

DETALLES CONEXIÓN SISTEMA DE AGUA POTABLE
ESC: S/E

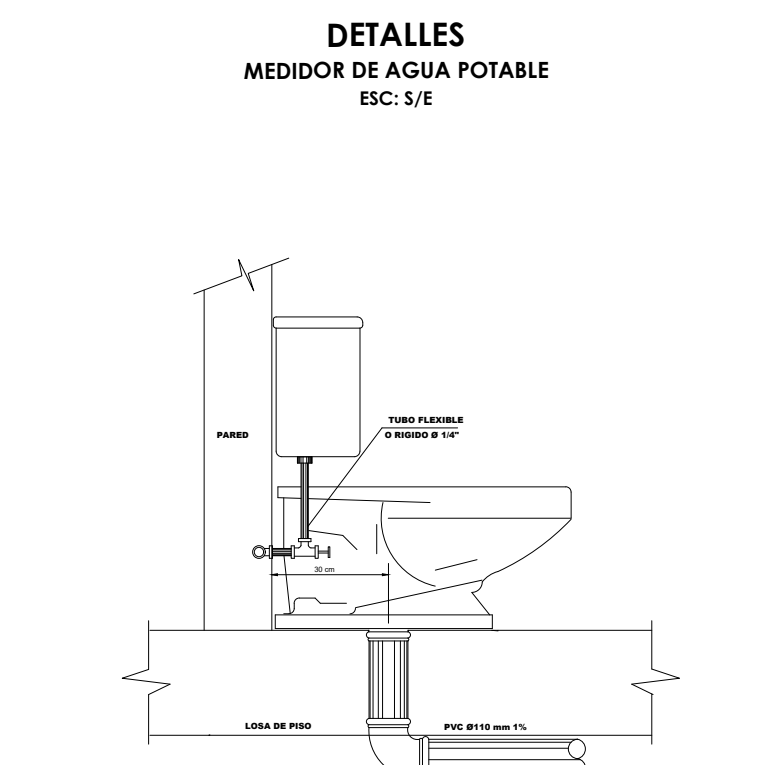

DETALLES CONEXIÓN SISTEMA DE AGUAS SERVIDAS
ESC: S/E

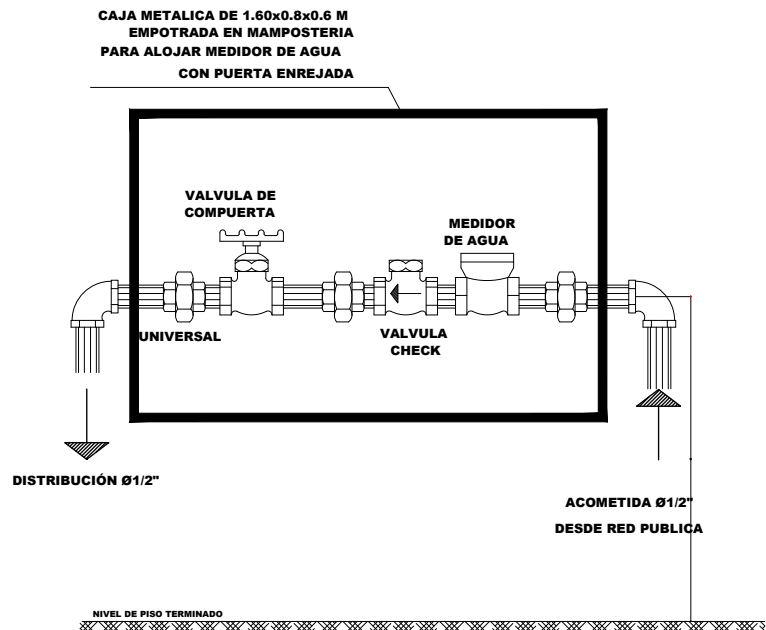
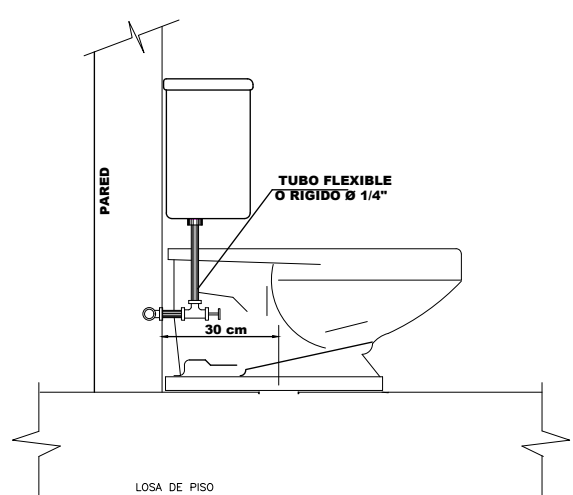
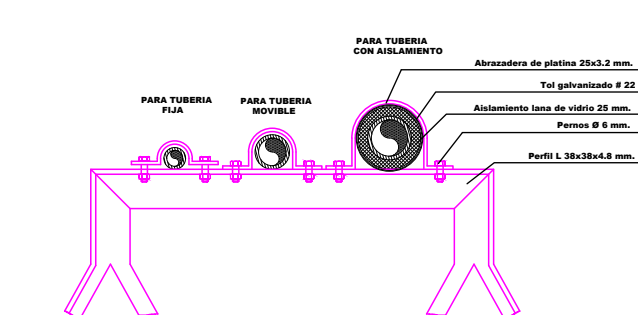
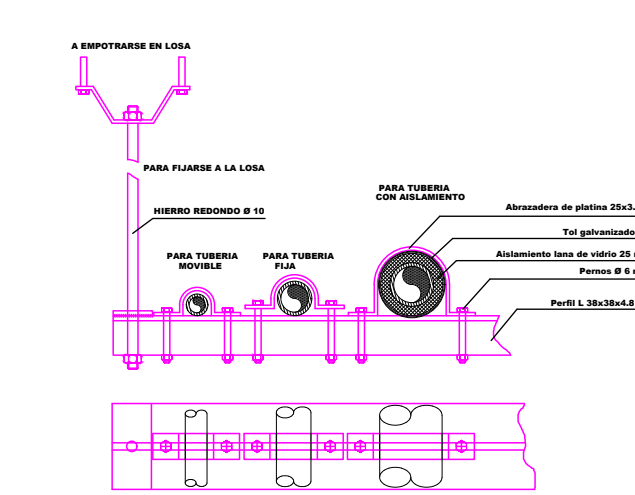

DETALLES SUMIDERO SISTEMA DE AGUAS LLUVIAS
ESC: S/E

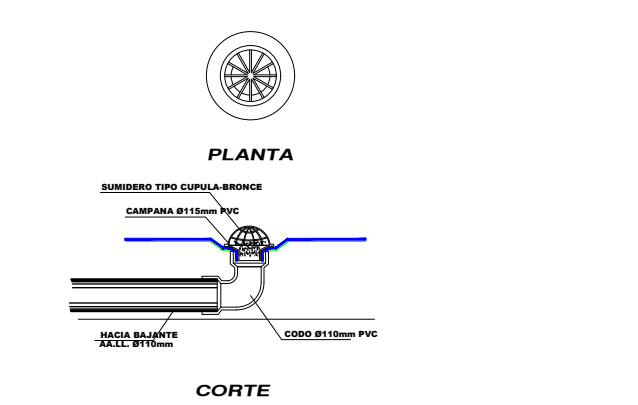

DETALLES CAJA SISTEMA DE AGUAS SERVIDAS Y AGUAS LLUVIAS
ESC: S/E

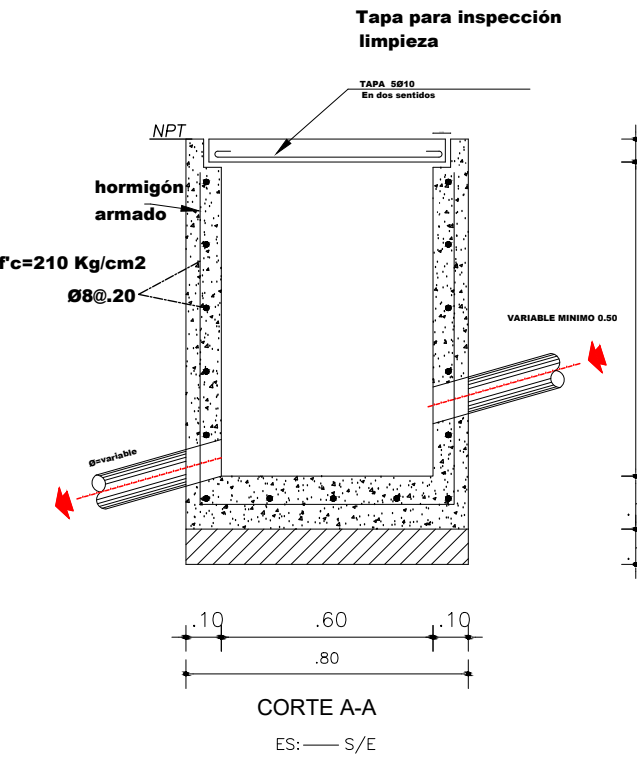
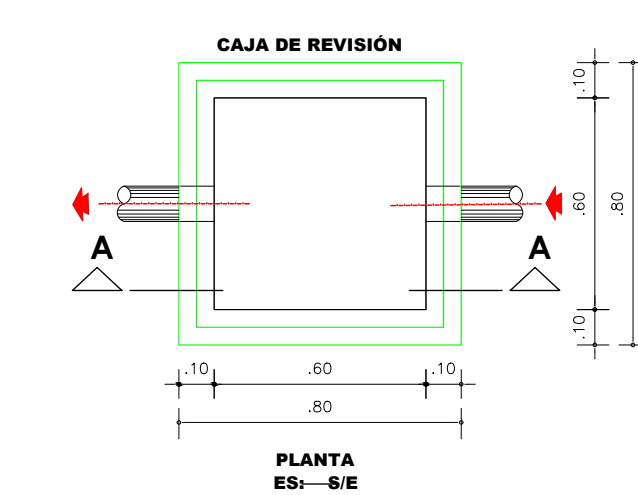

PROYECTO:
LA CASA DELLA NONA

UBICACION: Adm Zonal: Centro (Manuela Sáenz)
Parroquia: CENTRO HISTORICO
Barrio: LA LOMA

CONTIENE:	Nº DE PREDIO: 42214
	CLAVE CATASTRAL ANTERIOR: 2020 10 4007
	PRO CLAVE: T0103030136011111
	ZONIFICACION: H43(D203H-70)
	C.O.S.PB 70 %
	COS TOTAL 210 %

INSTALACIONES SANITARIAS
ING. Jefferson Campos
REG. PROF. SENESCYT: 1038-2021-2316920
CI. 1724740394

PROPIETARIO:
SRA. NELLY JARA
C.I. 1704120920

DIBUJO: R & R	LAMINA: IS1
FECHA: SEPTIEMBRE / 2024	DE: 1
ESCALA: INDICADAS	

SELLOS MUNICIPALES: